

| | |
|--------------------|-------|
| REDUCER SPEC | |
| MODEL | B063 |
| SERVICE FACTOR | 2.4 |
| RATIO | 10.26 |
| OUTPUT [rpm] | 171 |
| OUTPUT TORQUE [Nm] | 202 |
| WEIGHT [kg] | 25.9 |

| | |
|-------------|--------------------|
| MOTOR SPEC | |
| MODEL | TPA/112M4-220/380V |
| POWER [kW] | 4 |
| POLE, PHASE | 4P, 3PHASE |
| INPUT [rpm] | 1750 |
| BRAKE | NO |
| WEIGHT [kg] | 35 |

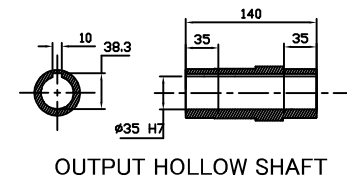
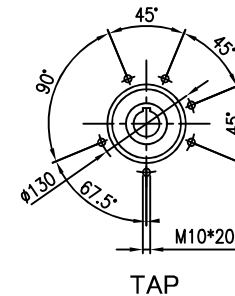
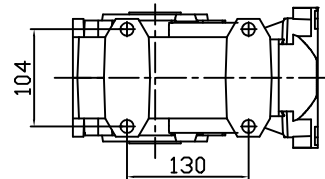
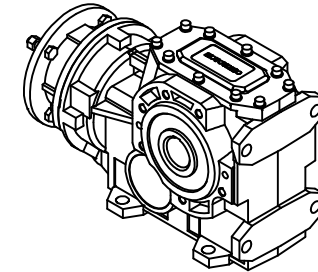
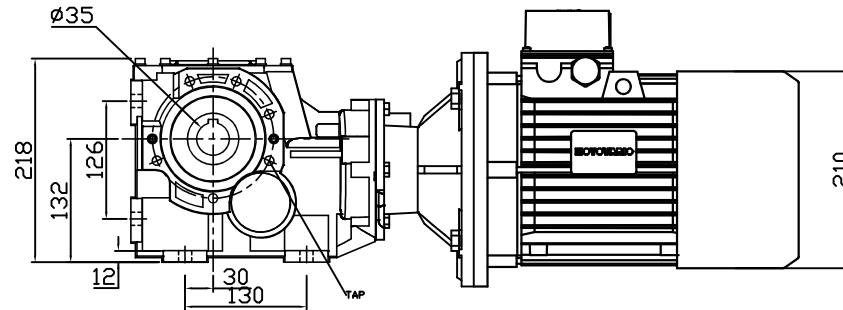
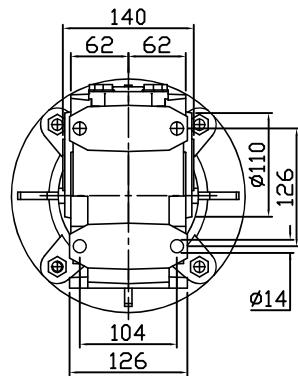

(주)한국체인모터

Tel. 032-815-8888 Fax. 815-8020
www.hcmfa.com

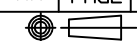
| | | | | | | |
|----------|---------|------|---|----|-------|-----|
| PROJECT | | | MOTOVARIO | | | |
| DRAWN | SEO Y.S | DATE | REV | A | SCALE | 1:1 |
| CHECKED | KIM J.S | DATE | UNIT | MM | PAGE | - |
| APPROVED | LEE J.Y | DATE |  | | | |